

FUNC- TION

22/23

Kian[®]

Better Design, Better Value, Better World

CONTENTS

Who We Are	06
Your Benefits	08
Chairs	10
Chair Accessories	22
Tables	24
Table Accessories	31
Mobile Stage	40
Rostrum	44
Front Office	46
Housekeeping	50
Room Service	60
Other Accessories	64
Materials & Swatches	66



WHO WE ARE

KIAN is a global market leader in the furniture industry with decades-long experience. We're leading the field because we've invested time in listening to the particular needs of our customers and can be relied on to come up with solutions for them. As an intelligent furniture solutions provider that exports to over 100 countries worldwide, we design, manufacture and directly supply to the commercial and residential sectors. KIAN has a worldwide logistics network with storage facilities and skilled local teams to service customers.

KIAN supplies original designs as well as bespoke pieces that are specially made for the Hotel and Accommodation Industry. We offer flexible, as well as comprehensive packages that can be tailored to your required budgets and styles. Or if you prefer, we also provide project management services where we oversee your project from end to end.



YOUR BENEFITS

01 OUR ECOSYSTEM

A trusted brand with global capabilities, we at KIAN aim to provide our customers with nothing but the best.

02 HUBS WITH SUPPLY CHAINS

With over 37 years of industry experience, we have developed a global network to better serve our customers from around the world.

03 AFFORDABLE PRICE

We believe that brands always deserve better. By value engineering our products, our customers will have access to high-quality furniture at affordable prices.

04 PROJECT MANAGEMENT & LOCAL SERVICE

From A to Z, let us handle the project management of your business. We even provide a localised service for wherever you are in the world.

CHAIRS

Built for comfort and functionality, our chairs are perfect for mobile and fast-paced environments. The chair frames are robotically welded with a powder coated finish, giving it durability for continuous use. The seat and backrest are also upholstered with high density foam for long-lasting plushness. Stackable up to 10 units to save space, our chairs also feature heavy-duty studs on the legs to provide stability while stacked and prevent gliding on uneven surfaces.



LUFFI MILD STEEL STACKING BANQUET CHAIR

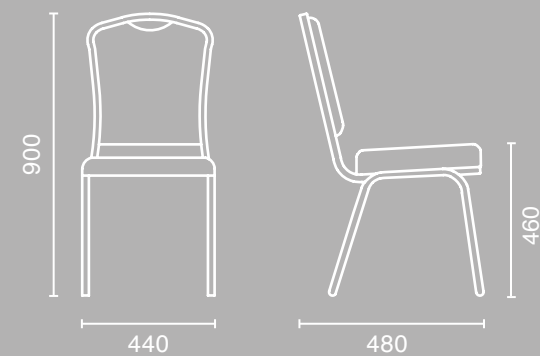

Frame:

- 19 x 19 x 1.2 thickness (mm)

Features:

- Robotic welded chair frame with powder coated finish.
- Moulded high density seat foam without exposed backrest.
- Heavy-duty studs 8 nos and 4 nos chair leg glides
- Stack up to 10 chairs.



KENMC-001



KENMC-003



KENMC-004



KENMC-005



KENMC-006



KENMC-007



KENMC-008



KENMC-009



KENMC-011



KENMC-012

FRANKIE ALUMINIUM STACKING BANQUET CHAIR

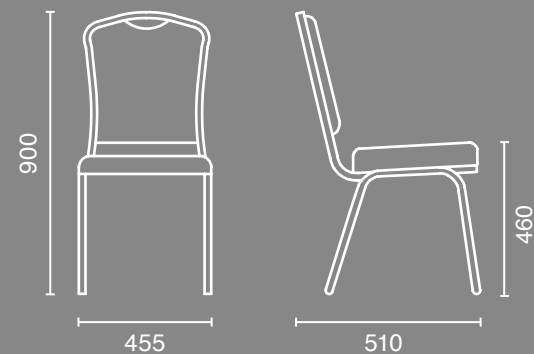

Frame:

- 25 x 25 x 2 thickness (mm)
- High-grade extruded aluminium

Features:

- Robotic welded chair frame with powder coated finish.
- Moulded high density seat foam without exposed backrest.
- Heavy-duty studs 8 nos and 4 nos chair leg glides.
- Frame option available.
- Stack up to 10 chairs.



KENAC-001



KENAC-002



KENAC-003



KENAC-004



KENAC-005



KENAC-006



KENAC-007



KENAC-008



KENAC-009



KENAC-010



KENAC-011



KENAC-012

Standard



B1



C1



D1



Frame profile options available

BROOK ALUMINIUM STACKING BANQUET CHAIR

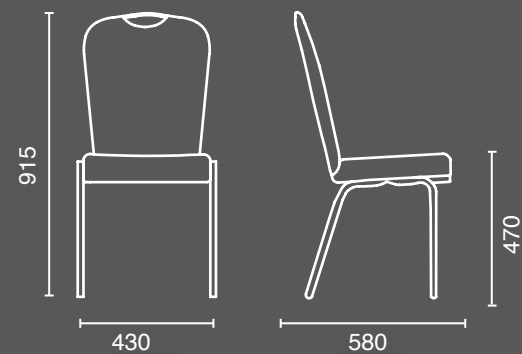

Frame:

- 25 x 25 x 2 thickness (mm)
- High-grade extruded aluminium

Features:

- Robotic welded chair frame with powder coated finish.
- Moulded high density seat foam without exposed backrest.
- Heavy-duty studs 8 nos and 4 nos chair leg glides
- Action backrest.
- Stack up to 6 chairs.



KENFC-001



KENFC-002



KENFC-003



KENFC-004



KENFC-005



KENFC-006



KENFC-007



KENFC-008



KENFC-009



Action back feature

ROBIN MILD STEEL STACKING BANQUET CHAIR

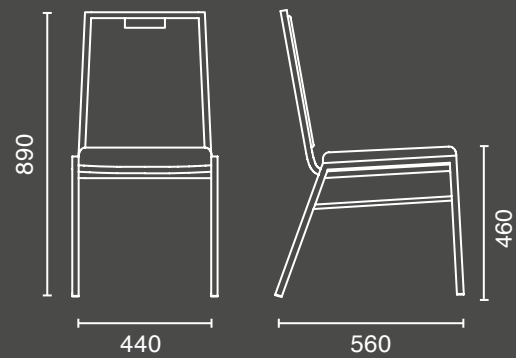

Frame:

- 19 x 19 x 1.2 thickness (mm)

Features:

- Robotic welded chair frame with powder coated / chrome finish
- Moulded high density seat foam without exposed backrest
- Sculpted waterfall seat for ergonomic design
- Lumbar support backrest for extra comfort
- Heavy-duty studs 8 nos and 4 nos chair leg glides
- Stack up to 10 chairs.



KENCL-001



KENCL-002



KENCL-003



KENCL-004



KENCL-005



KENCL-006



KENCL-007



Feature: Handle grip
Optional: Bag hook

BONNY MILD STEEL STACKING BANQUET CHAIR

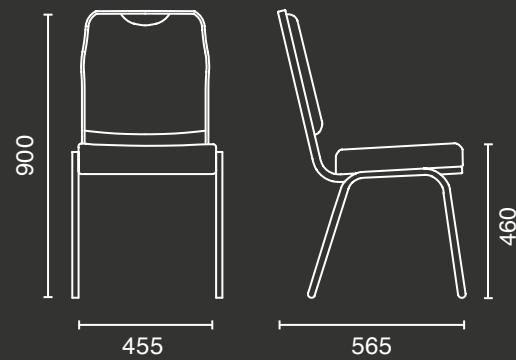

Backrest Frame:

- 16 x 16 x 1.6 thickness (mm)

Leg Frame:

- 19 x 19 x 1.2 thickness (mm)

Features:

- Robotic welded chair frame with powder coated / chrome finish.
- Moulded high density seat foam without exposed backrest.
- Heavy-duty studs 8 nos and 4 nos chair leg glides
- Sculpted waterfall seat for ergonomic design
- Lumbar support backrest for extra comfort



KENRC - 001



KENRC - 002



KENRC - 004



KENRC - 005



KENRC - 006

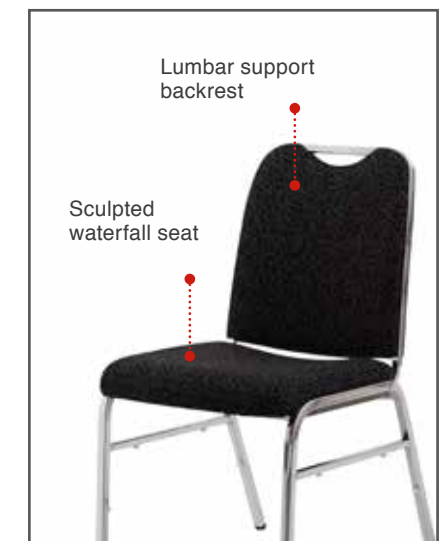

Lumbar support
backrest

Sculpted
waterfall seat

BANQUET CHAIR TROLLEY WITH CARPETED TOP

KEBCT-01

MEASUREMENT

W381 x D686 x H1069mm

MATERIALS

- Mildsteel round tube 25mm with powder coated finish
- 8" diameter heavy-duty non marking wheels
- Carpeted platform
- Stacked up to 10 chairs



BANQUET CHAIR TROLLEY WITH CARPETED TOP

KEBCT-02

MEASUREMENT

W406 x D1220x H1118mm

MATERIALS

- Mildsteel round tube with powder coated finish
- 4 nos of wheels (2nos - 3" diameter and 2 nos - 8" diameter)
- Easy movement and transportation of chairs
- Carpeted platform and backrest
- Stacked up to 10 chairs



TRANSPORTATION TROLLEY FOR BANQUET CHAIR

KECT-03

MEASUREMENT

W510 x D1195 x H150mm

FEATURES

- Stacks up to 2 rows of 10 chairs each row
- Carpeted platform
- Heavy-duty wheels



TRANSPORTATION TROLLEY FOR BANQUET CHAIR

KECT-04

MEASUREMENT

W510 x D610 x H150mm

FEATURES

- Stacks up to 10 chairs
- Carpeted platform
- Heavy-duty wheels



BABY CHAIR

KEBB-01

MEASUREMENT

W560 x D395 x H890 x SH640mm

FRAME

Mild steel in powder coated

UPHOLSTERY

PVC/ Fabric

FEATURES

- Flip-up fibreglass tray with safety belt



WOODEN BABY CHAIR

KEBB-02

MEASUREMENT

W445 x D455 x H800 x SH530mm

FEATURES

- Comes with safety belt
- Cushion seat for extra comfort



TABLES

Convenience for any occasion. Our wide range of tables ensure long-lasting usage with their sturdy leg base that has been reinforced with additional support bars. The tables also come with a leg folding spring mechanism that allows for stacking and easy manoeuvrability. Additionally, heavy-duty nylon studs have been installed to the table legs to prevent falling when folded and prevent gliding on uneven surfaces.



LUFFI BANQUET TABLE

TABLETOP

- Bonded artificial white vinyl top
- 18mm plywood base with heavy-duty T-Mould PVC edging all around
- HPL laminated tabletop option available

TABLE BASE:

- Size: W30mm x D30mm x thickness 1.2mm
- Mild steel black powder coated finish with anti-rust treatment

FEATURES

- Reinforced leg base with additional support bars
- Heavy-duty folding spring leg mechanism
- Heavy-duty nylon studs riveted for stacking
- Non fall out adjustable leg glides for uneven flooring



Safety catch lock to ensure the base secured in position and to prevent the base from reopening after folded.

Additional handle to ease lifting the table

PVC studs protects the leg frame when stacked together



T-Mould PVC Edge

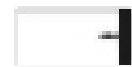

LUFFI HALF-ROUND TABLE



Model No	W x D x H(mm)
KENHRT-24/48	1220 x 610 x 760
KENHRT-30/60	1525 x 760 x 760
KENHRT-36/72	1830 x 915 x 760
KENHRT-48/96	2440 x 1220 x 760

LUFFI CRESENT TABLE



Model No	W x D x H(mm)
KENCRT-30/60	1525 x 760 x 760
KENCRT-30/70	1830 x 760 x 760
KENCRT-30/84	2440 x 760 x 760
KENCRT-36/72	1830 x 915 x 760

LUFFI RECTANGULAR TABLE



Model No	W x D x H(mm)
KENRCT-18/60	1525 x 460 x 760
KENRCT-24/60	1525 x 610 x 760
KENRCT-30/60	1525 x 760 x 760
KENRCT-36/60	1525 x 915 x 760
KENRCT-18/72	1830 x 460 x 760
KENRCT-24/72	1830 x 610 x 760
KENRCT-30/72	1830 x 760 x 760
KENRCT-36/72	1830 x 915 x 760
KENRCT-18/84	2135 x 460 x 760
KENRCT-24/84	2135 x 610 x 760

KENRCT-30/84	2135 x 760 x 760
KENRCT-36/84	2135 x 915 x 760
KENRCT-18/96	2440 x 460 x 760
KENRCT-24/96	2440 x 610 x 760
KENRCT-30/96	2440 x 760 x 760
KENRCT-36/96	2440 x 915 x 760

LUFFI ROUND TABLE



Model No	DIA x H(mm)
KENRDT-24	610 x 760
KENRDT-30	760 x 760
KENRDT-36	915 x 760
KENRDT-42	1065 x 760
KENRDT-48	1220 x 760
KENRDT-54	1370 x 760
KENRDT-60	1525 x 760
KENRDT-66	1675 x 760
KENRDT-72	1830 x 760
KENRDT-84	2135 x 760

LUFFI SQUARE TABLE



Model No	W x D x H(mm)
KENSQT-24	610 x 610 x 760
KENSQT-30	760 x 760 x 760
KENSQT-36	915 x 915 x 760
KENSQT-48	1220 x 1220 x 760

LUFFI QUARTER-ROUND TABLE



Model No	W x D x H(mm)
KENQRT-24	610 x 610 x 760
KENQRT-30	760 x 760 x 760
KENQRT-36	915 x 915 x 760
KENQRT-48	1220 x 1220 x 760

VULCAN CONFERENCE TABLE

TABLETOP

- 18mm thickness plywood base with laminated top
- Heavy-duty T-Mould PVC edging all around
- Polyresin Tuff Edge and PU Top Edge edging options available

TABLE BASE:

- Mild steel black powder coated finish with anti-rust treatment
- Chrome finish option available

FEATURES

- T Base folding Leg with easy lock
- Heavy-duty nylon studs riveted for stacking
- Non fall out adjustable leg glides for uneven flooring

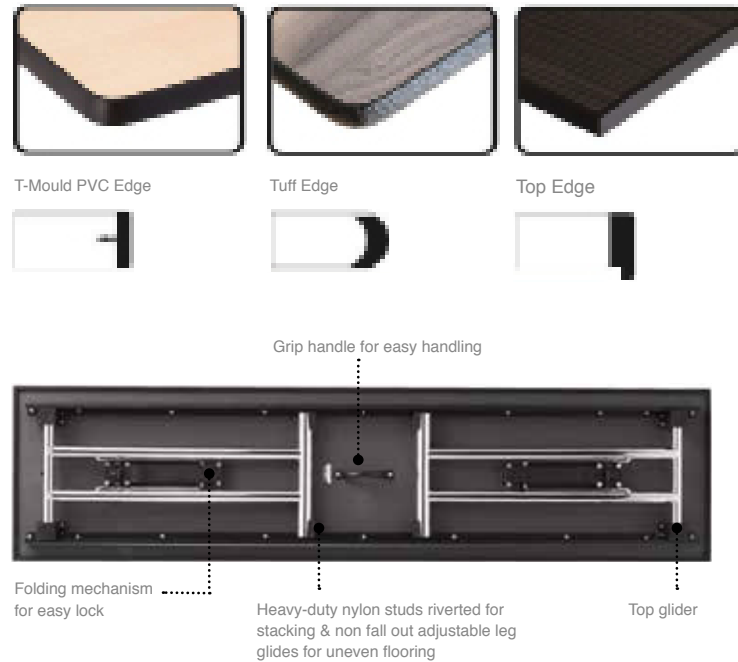

VULCAN QUARTER-ROUND TABLE (FIXED BASE)



Model No	W x D x H(mm)
KECQRT-P-24	610 x 610 x 760
KECQRT-P-30	760 x 760 x 760
KECQRT-P-36	915 x 915 x 760
KECQRT-P-48	1220 x 1220 x 760

VULCAN SQUARE TABLE (FIXED BASE)



Model No	W x D x H(mm)
KECSQT-P-24	610 x 610 x 760
KECSQT-P-30	760 x 760 x 760
KECSQT-P-36	915 x 915 x 760
KECSQT-P-48	1220 x 1220 x 760

VULCAN CRESCENT TABLE



Model No	W x D x H(mm)
KECNCT-P-30/70	1780 x 760 x 760
KECNCT-P-30/84	2135 x 760 x 760
KECNCT-P-36/70	1780 x 915 x 760
KECNCT-P-36/84	2135 x 915 x 760

VULCAN HALF-ROUND TABLE



Model No	W x D x H(mm)
KECHRT-P-24/48	1220 x 610 x 760
KECHRT-P-30/60	1524 x 760 x 760
KECHRT-P-36/72	1830 x 915 x 760
KECHRT-P-48/96	2440 x 1220 x 760

VULCAN OVAL TABLE



Model No	W x D x H(mm)
KECORT-P-36/72	1830 x 915 x 760
KECORT-P-60/72	1830 x 1530 x 760
KECORT-P-42/84	2135 x 1065 x 760
KECORT-P-48/84	2135 x 1220 x 760
KECORT-P-48/96	2440 x 1220 x 760

VULCAN RECTANGULAR TABLE



Model No	W x D x H(mm)
KECRCT-T-D-18/48	1220 x 460 x 760
KECRCT-T-D-24/48	1220 x 610 x 760
KECRCT-T-D-30/48	1220 x 760 x 760
KECRCT-T-D-36/48	1220 x 915 x 760
KECRCT-T-D-18/60	1530 x 460 x 760
KECRCT-T-D-24/60	1530 x 610 x 760
KECRCT-T-D-30/60	1530 x 760 x 760
KECRCT-T-D-36/60	1530 x 915 x 760
KECRCT-T-D-18/72	1830 x 460 x 760
KECRCT-T-D-24/72	1830 x 610 x 760
KECRCT-T-D-30/72	1830 x 760 x 760
KECRCT-T-D-36/72	1830 x 915 x 760
KECRCT-T-D-18/84	2134 x 460 x 760
KECRCT-T-D-24/84	2134 x 610 x 760
KECRCT-T-D-30/84	2134 x 760 x 760
KECRCT-T-D-36/84	2134 x 915 x 760
KECRCT-T-D-18/96	2440 x 460 x 760
KECRCT-T-D-24/96	2440 x 610 x 760
KECRCT-T-D-30/96	2440 x 760 x 760
KECRCT-T-D-36/96	2440 x 915 x 760

VULCAN RECTANGULAR TABLE

with Fixed Dual Foldable Modesty Panel



Model No	W x D x H(mm)
KECRCT-MPD/P-18/48	1220 x 460 x 760
KECRCT-MPD/P-24/48	1220 x 610 x 760
KECRCT-MPD/P-30/48	1220 x 760 x 760
KECRCT-MPD/P-36/48	1220 x 915 x 760
KECRCT-MPD/P-18/60	1530 x 460 x 760
KECRCT-MPD/P-24/60	1530 x 610 x 760
KECRCT-MPD/P-30/60	1530 x 760 x 760
KECRCT-MPD/P-36/60	1530 x 915 x 760
KECRCT-MPD/P-18/72	1830 x 460 x 760
KECRCT-MPD/P-24/72	1830 x 610 x 760
KECRCT-MPD/P-30/72	1830 x 760 x 760
KECRCT-MPD/P-36/72	1830 x 915 x 760

VULCAN RECTANGULAR TABLE

with Removable Modesty Panel



Model No	W x D x H(mm)
KECRCT-MPD/P-18/84	2135 x 460 x 760
KECRCT-MPD/P-24/84	2135 x 610 x 760
KECRCT-MPD/P-30/84	2135 x 760 x 760
KECRCT-MPD/P-36/84	2135 x 915 x 760
KECRCT-MPD/P-18/96	2440 x 460 x 760
KECRCT-MPD/P-24/96	2440 x 610 x 760
KECRCT-MPD/P-30/96	2440 x 760 x 760
KECRCT-MPD/P-36/96	2440 x 915 x 760

REGISTRATION TABLE

(Boxup Table)

TABLETOP

- 18mm thickness plywood base with laminated top
- Heavy-duty T-Mould PVC edging all around

TABLE BASE:

- W32mm x D32mm x thickness 1.2mm
- Mild steel black powder coated finish with anti-rust treatment

FEATURES

- Comes with 3-piece front and side panels in woodgrain laminate and T-Mould PVC edging all round.



Model No	W x D x H (H2) (mm)
KECREG-18/60	1530 x 460 x 760
KECREG-24/60	1530 x 610 x 760
KECREG-30/60	1530 x 762 x 760
KECREG-36/60	1530 x 915 x 760
KECREG-18/72	1830 x 458 x 760
KECREG-24/72	1830 x 610 x 760
KECREG-30/72	1830 x 760 x 760
KECREG-36/72	1830 x 915 x 760

SOMA BANQUET TABLE

TABLETOP

- Bonded artificial white leather top on 18mm plywood base with heavy-duty T-Mould PVC edging all around.
- HPL laminated tabletop option available.

TABLE BASE:

- V shape leg size in 32 x 32 x 1.2 thickness (mm)
- Mild steel black powder coated finish with anti-rust treatment
- Chrome finish option available

FEATURES

- Reinforced leg base with additional support bars for added strength
- Heavy-duty folding spring leg mechanism
- Heavy-duty nylons studs riveted for stacking
- Non fall out adjustable leg glides for uneven flooring



Safety catch lock to ensure the base secured in position and to prevent the base from reopening after folded.



Added strength with reinforced leg base with additional support bars.



Heavy-duty nylon studs riveted for stacking & non fall out adjustable leg glides for uneven flooring.



T-Mould PVC Edge



Model No	Dia x H(mm)
KENRTV-60	1525 x 760
KENRTV-66	1675 x 760
KENRTV-72	1830 x 760
KENRTV-84	2135 x 760
KENRTV-96	2440 x 760

TABLE ACCESSORIES



ROUND TABLE TROLLEY
KERT-01
W1981 x D915 x H1118mm



FLAT TABLE TROLLEY
KEFT-02
W1981 x D915 x H1118mm

FLIP / FIXED TOP COCKTAIL TABLE

with Pedestal Table Base & Castors

TABLETOP

Laminated top with heavy duty T-Mould PVC edging.

TABLE BASE

Mild steel in black powder coated finish with anti-rust treatment. Chrome finish option available

FEATURES

- Comes with heavy-duty lockable castors



FIXED TOP	DIA x H(mm)
KENCTL-FT-24	610 x 1065
KENCTL-FT-30	760 x 1065
KENCTL-FT-36	915 x 1065

FLIP TOP	DIA x H(mm)
KENCTL-FL-24	610 x 1065
KENCTL-FL-30	760 x 1065
KENCTL-FL-36	915 x 1065

FLIP / FIXED TOP COCKTAIL TABLE

with Pedestal Table Base

TABLETOP

Laminated top with heavy duty T-Mould PVC edging

TABLE BASE

Mild steel central column with pedestal table base



FIXED TOP	DIA x H(mm)
KENDTL-FT-24	610 x 1065
KENDTL-FT-30	760 x 1065
KENDTL-FT-36	915 x 1065

FLIP TOP	DIA x H(mm)
KENDTL-FL-24	610 x 1065
KENDTL-FL-30	760 x 1065
KENDTL-FL-36	915 x 1065

FLIP / FIXED TOP COCKTAIL TABLE

with Pedestal Table Base & Castors

TABLETOP

Laminated top with heavy duty T-Mould PVC edging

TABLE BASE

Mild steel in black powder coated finish & chrome column with anti-rust treatment. All chrome finish option available

FEATURES

- Comes with heavy-duty lockable castors
- Bush Locking adjustable height 30"/36"/42"



FIXED TOP	DIA x H(mm)
KENCTL-FT-AH-24	610 x 760-1065
KENCTL-FT-AH-30	760 x 760-1065
KENCTL-FT-AH-36	915 x 760-1065

FLIP TOP	DIA x H(mm)
KENCTL-FL-AH-24	610 x 760-1065
KENCTL-FL-AH-30	760 x 760-1065
KENCTL-FL-AH-36	915 x 760-1065

SISI COCKTAIL TABLE

TABLETOP

10mm thick clear tempered glass

TABLE BASE

Mild steel in powder coated finish



Model No	DIA x H (mm)
KENCTL-MS-24	610 x 1065
KENCTL-MS-30	760 x 1065
KENCTL-MS-36	915 x 1065

FLIP / FIXED TOP COCKTAIL TABLE

with Tulip Table Base

TABLETOP

Laminated top with heavy duty T-Mould PVC edging

TABLE BASE

Mild steel central column tube with flat round base in black powder coated finish. Chrome finish option available



FIXED TOP	DIA x H(mm)
KENFTCT-24	610 x 1065
KENFTCT-30	760 x 1065
KENFTCT-36	915 x 1065

FLIP TOP	DIA x H(mm)
KENFTCT-FL-24	610 x 1065
KENFTCT-FL-30	760 x 1065
KENFTCT-FL-36	915 x 1065

FOLDABLE COCKTAIL TABLE

TABLETOP

10mm thick clear tempered glass

TABLE BASE

Wrought Iron in powder coated finish

FEATURES

- With 2 pcs hinges and 4 pcs rubber studs
- Foldable for easy storage



Model No	DIA x H(mm)
KENFCT-WI-24	610 x 1050
KENFCT-WI-28	700 x 1050
KENFCT-WI-36	915 x 1050

FOLDABLE ROUND BUFFET TABLE

TABLETOP
10mm thick clear tempered glass

TABLE BASE
Mild steel in powder coated finish
Stainless steel SS304 tube in hairline finish

- FEATURES**
- Foldable for easy storage



MILD STEEL FRAME	DIA x H (mm)	STAINLESS STEEL FRAME	DIA x H (mm)
KENFBT-MS-24	600 x 1050	KENFBT-SS-24	600 x 1050
KENFBT-MS-28	700 x 1050	KENFBT-SS-28	700 x 1050
KENFBT-MS-30	760 x 1050	KENFBT-SS-30	760 x 1050
KENFBT-MS-35	900 x 1050	KENFBT-SS-35	900 x 1050

TWO-TIER ROUND FOLDABLE BUFFET TABLE

TABLETOP
10mm thick clear tempered glass

TABLE BASE
Mild steel in powder coated finish
Stainless steel SS304 tube in hairline finish

- FEATURES**
- Foldable for easy storage



MILD STEEL FRAME	DIA x H (mm)	STAINLESS STEEL FRAME	DIA x H (mm)
KENFBT-2T-MS-24	610 x 1050	KENFBT-2T-SS-24	610 x 1050
KENFBT-2T-MS-28	700 x 1050	KENFBT-2T-SS-28	700 x 1050
KENFBT-2T-MS-30	760 x 1050	KENFBT-2T-SS-30	760 x 1050
KENFBT-2T-MS-35	900 x 1050	KENFBT-2T-SS-35	900 x 1050

FOLDABLE SQUARE BUFFET TABLE

TABLETOP
10mm thick clear tempered glass

TABLE BASE
Mild steel in powder coated finish
Stainless steel SS304 tube in hairline finish

- FEATURES**
- Foldable for easy storage



MILD STEEL FRAME	W x D x H(mm)	STAINLESS STEEL FRAME	W x D x H(mm)
KEFBTSQ-MS-24	610 x 600 x 1050	KEFBTSQ-SS-24	610 x 600 x 1050
KEFBTSQ-MS-30	760 x 760 x 1050	KEFBTSQ-SS-30	760 x 760 x 1050
KEFBTSQ-MS-35	900 x 900 x 1050	KEFBTSQ-SS-35	900 x 900 x 1050

RECTANGULAR BUFFET TABLE 4H

1 set consists of 4 tables

TABLETOP
12mm thick clear tempered glass

TABLE BASE
Mild steel in powder coated finish
Stainless steel SS304 tube in hairline finish



MILD STEEL FRAME	W x D x H (mm)	STAINLESS STEEL FRAME	W x D x H (mm)
KENBFT-RG-MS-SET4	1150 x 760 x 695	KENBFT-RG-SS-SET4	1150 x 760 x 695
	1300 x 760 x 830		1300 x 760 x 830
	1450 x 760 x 965		1450 x 760 x 965
	1600 x 760 x 1100		1600 x 760 x 1100

RECTANGULAR BUFFET TABLES

1 set consists of 4 tables

TABLETOP
12mm thick clear tempered glass

TABLE BASE
Mild steel in powder coated finish
Stainless steel SS304 tube in hairline finish



MILD STEEL FRAME	W x D x H (mm)	STAINLESS STEEL FRAME	W x D x H (mm)
KENBFT-RG-MS-SET4	1150 x 760 x 695	KENBFT-RG-SS-SET4	1150 x 760 x 695
	1300 x 760 x 830		1300 x 760 x 830
	1450 x 760 x 965		1450 x 760 x 965
	1600 x 760 x 1100		1600 x 760 x 1100

RECTANGULAR BUFFET TABLE 3H

1 set consists of 4 tables

TABLETOP
12mm thick clear tempered glass

TABLE BASE
Mild steel in powder coated finish
Stainless steel SS304 tube in hairline finish

- FEATURES**
- Comes with heavy-duty wheels with brakes



MILD STEEL FRAME	W x D x H (mm)	STAINLESS STEEL FRAME	W x D x H (mm)
KENBFT-RCT-MSW-SET4	1680 x 850 x 900	KENBFT-RCT-SSW-SET4	1680 x 850 x 900
	1516 x 800 x 818		1516 x 800 x 818
	651 x 750 x 736		651 x 750 x 736
	651 x 750 x 736		651 x 750 x 736

SQUARE BUFFET TABLES

1 set consists of 4 tables

TABLETOP

12mm thick clear tempered glass

TABLE BASE

Mild steel in powder coated finish.
Stainless steel SS304 tube in hairline finish



MILD STEEL FRAME	W x D x H (mm)	STAINLESS STEEL FRAME	W x D x H (mm)
KENBFT-SQT-MS-SET4	760 x 760 x 695	KENBFT-SQT-SS-SET4	760 x 760 x 695
	910 x 910 x 830		910 x 910 x 830
	1060 x 1060 x 965		1060 x 1060 x 965
	1210 x 1210 x 1100		1210 x 1210 x 1100

TRIANGLE BUFFET TABLES

TABLETOP

12mm thick clear tempered glass

TABLE BASE

Mild steel in powder coated finish.
Stainless steel SS304 tube in hairline finish



MILD STEEL FRAME	W x D x H (mm)	STAINLESS STEEL FRAME	W x D x H (mm)
KENBFT-TRG-MS-SET4	760 x 760 x 695	KENBFT-TRG-SS-SET4	760 x 760 x 695
	910 x 910 x 830		910 x 910 x 830
	1060 x 1060 x 965		1060 x 1060 x 965
	1210 x 1210 x 1100		1210 x 1210 x 1100

HALF-ROUND BUFFET TABLES

1 set consists of 4 tables

TABLETOP

12mm thick clear tempered glass

TABLE BASE

Mild steel in powder coated finish.
Stainless steel SS304 tube in hairline finish



MILD STEEL FRAME	W x D x H (mm)	STAINLESS STEEL FRAME	W x D x H (mm)
KENBFT-HRT-MS-SET4	760 x 380 x 695	KENBFT-HRT-SS-SET4	760 x 380 x 695
	910 x 455 x 830		910 x 455 x 830
	1060 x 530 x 965		1060 x 530 x 965
	1210 x 605 x 1100		1210 x 605 x 1100

RECTANGULAR MOBILE BUFFET TABLE

1 set consists of 4 tables

TABLETOP

18mm laminated top with ABS edging

TABLE FRAME

Mild steel in powder coated finish
Stainless steel SS304 tube in hairline finish

FEATURES

- Foldable for easy storage



MILD STEEL FRAME	W x D x H(mm)	STAINLESS STEEL FRAME	W x D x H(mm)
KENBFT-RCT/MS-35/51	1800 x 900 x 1230	KENBFT-RCT/SS-35/51	1800 x 900 x 1230

SQUARE MOBILE BUFFET TABLE

TABLETOP

10mm thick clear tempered glass

TABLE FRAME

Mild steel in powder coated finish
Stainless steel SS304 tube in hairline finish

FEATURES

- Foldable for easy storage



MILD STEEL FRAME	W x D x H(mm)	STAINLESS STEEL FRAME	W x D x H(mm)
KENBFT-SQT/MS-35/35	900 x 900 x 1050	KENBFT-SQT/SS-35/35	900 x 900 x 1050

SQUARE MOBILE BUFFET HIGH TABLE

TABLETOP

18mm laminated top with ABS edging

TABLE FRAME

Mild steel in powder coated finish
Stainless steel SS304 tube in hairline finish

FEATURES

- Foldable for easy storage



MILD STEEL FRAME	W x D x H (mm)	STAINLESS STEEL FRAME	W x D x H (mm)
KENBFT-SQT/MS-18/48H	460 x 460 x 1220	KENBFT-SQT/SS-18/48H	460 x 460 x 1220

TIER STEPS BUFFET TABLE

TABLETOP
10mm thick clear tempered glass

TABLE FRAME
Mild steel in powder coated finish
Stainless steel SS304 tube in hairline finish



MILD STEEL FRAME	W x D x H (mm)
KENBFT-SQT/MS-33/54H	840 x 840 x 1370

STAINLESS STEEL FRAME	W x D x H (mm)
KENBFT-SQT/SS-33/54H	840 x 840 x 1370



STABILUS MOBILE STAGE & ROSTRUM

Mild steel black powder coated collapsible base



Heavy-duty construction frame with locking side connectors

No heavy sections to carry and no storage caddies needed

Mobile folding stage moves freely on four wheels

Operating instructions



STABILUS MOBILE STAGE

SIZE

W4ft x L8ft & W6ft x L8ft
Single/Dual/Triple Height Options

WEIGHT

1500kg per stage

PLATFORM

- Core 18mm plywood
- Aluminium side trimming
- Carpeted

FRAME

- Heavy-duty construction main frame.
- 2" x 2" angle iron robotic welded mild steel black powder coated collapsible base.
- Mobile folding stage moves freely on 5" diameter wheels, 2 swivel & 2 rigid with non marking grey heavy-duty castors.
- Side connectors and comes with Velcro on every side of the stage enables quick and easy stage skirting attachment.
- T-handle ball bearing insert to ensure easy height adjustments and locking to prevent during usage.
- Protective black banding provides long lasting wear durability.
- Ganging mechanism ensures stages are safely secure together.



Single Height Stage

Model No	W x D x H(mm)
KENMSS-610	2440 x 1220 x 230
KENMSS-611	2440 x 1220 x 405
KENMSS-612	2440 x 1220 x 610
KENMSS-613	2440 x 1220 x 815
KENMSS-614	2440 x 1220 x 1015

Single Height Stage

Model No	W x D x H(mm)
KENMSS-610-68	2440 x 1830 x 230
KENMSS-611-68	2440 x 1830 x 405
KENMSS-612-68	2440 x 1830 x 610
KENMSS-613-68	2440 x 1830 x 815
KENMSS-614-68	2440 x 1830 x 1015



Dual Height Stage

Model No	Size (mm)
KENMSD-620	2440 x 1220 x 405/610
KENMSD-621	2440 x 1220 x 610/815
KENMSD-622	2440 x 1220 x 815/1015

Dual Height Stage

Model No	Size (mm)
KENMSD-620-68	2440 x 1830 x 405/610
KENMSD-621-68	2440 x 1830 x 610/815
KENMSD-622-68	2440 x 1830 x 815/1015



Tri Height Stages

Model No	Size (mm)
KENMST-630	2440 x 1220 x 405/610/760
KENMST-631	2440 x 1220 x 610/760/915

Tri Height Stages

Model No	Size (mm)
KENMST-630-68	2440 x 1830 x 405/610/760
KENMST-631-68	2440 x 1830 x 610/760/915

STAGE SKIRTING

SIZE:
2440mm Length

CHOICE OF COLOURS
Black / Maroon

- FEATURES**
- Micro suede shimmed pleat design
 - Available in single , dual / tri height with velcro



BOOGIE PORTABLE DANCE FLOOR

KENPDF-202
W922 x D922 x H25mm

CORE
High-grade treated teak wood

SURFACE
Select grade 6mm basket weave solid teak wood parquet.

EDGE
6mm thickness aluminium tonque & groove moulding, protects edges and acts as part of the locking and leveling system.

- FEATURES**
- Square panel with teak wood parquet
 - Using Hex screw for locking mechanism



KENPDF-203 (DFTT-SL-01)
Centre border trims
Size: W127mm
Colours: Silver / Gold

KENPDF-204 (DFTT-SL-02)
Centre border trims
Size: W127mm
Colours: Silver / Gold

STABILUS STEP RISE

- FEATURES**
- Mild steel black colour powder coated finish
 - Fixed height
 - Carpeted

Model	L x D x H (mm)
KENTSR-640	966 x 660 x 407
KENTSR-641	966 x 660 x 1372
KENTSR-642	966 x 978 x 610
KENTSR-643	966 x 978 x 1600



KENTSR-640
2 - steps rise without handrail



KENTSR-642
3 - steps rise without handrail



KENTSR-641
2 - steps rise with handrail



KENTSR-643
3 - steps rise with handrail

BOOGIE DANCE FLOOR TROLLEY

KENDFT-205
W1169 x D966 x H1067

- FEATURES**
- Carpeted platform
 - Mild steel black powder coated finish
 - 8" diameter Nylon wheels
 - Capacity to hold up to 25 panels



ROCK IT
ROSTRUM**KENRSR-710**

W550 x D570 x H1170mm

MATERIAL

Solid Wood Finish With Stainless Steel Combination

ACCESSORIES

- Acrylic logo
- Reading light
- Microphone connector
- Power plug
- Comes with 2" diameter heavy-duty wheels :
2nos lockable swivel and 2nos rigid wheels

CUSTOM MADE
ROSTRUM**KENRSR-740**

W546 x D565 x H1362mm

FEATURES

- Stainless Steel 304 Woodgrain Laminate
- Pull out shelf at bottom to stand on microphone
- 2 x IVA professional condensor 14"(L) gooseneck footrest stand
- 2" diameter wheels (2 Rigid + 2 Lockable Swivel)
- Reclining reading tablet
- 1 x Gooseneck lighting
- 1 x Power outlet
- 1 x Mini audio jack
- 1 x VGA connector
- 1 x 10Ft Wire with 3-pin plug

ROCK IT
ROSTRUM**KENRSR-720**

W610 x D610 x H1250mm

MATERIAL

Solid Wood Finish with Stainless Steel Combination

ACCESSORIES

- Acrylic logo
- Reading light
- Microphone connector
- Power plug

V-SHAPE
ROSTRUM**KENRSR-750**

W547 x D737 x H1156mm

MATERIAL

Nyatoh wood walnut finished on castors with stainless steel hairline finished base

ACCESSORIES

- Acrylic logo
- Reading light
- Microphone connector
- Power plug

ROCK IT
ROSTRUM**KENRSR-730**

W550 x L570 x H1170mm

MATERIAL

Solid Wood Finish with Stainless Steel Combination

ACCESSORIES

- Acrylic logo
- Reading light
- Microphone connector
- Power plug
- Comes with 2" diameter heavy-duty wheels :
2nos lockable swivel and 2nos rigid wheels



FRONT OFFICE TROLLEY

Put your customers at ease and give them the proper hospitality treatment with our Front Office Trolleys. Choose from a variety of shapes and sizes to suit the needs of your customers. The frame is made of stainless steel for durability and strength, and imported castor wheels with thick bumpers have been installed for easy manoeuvrability.



BIRDCAGE TROLLEY

KENFOT-01
L1168 x D710 x H1854mm

FRAME
Stainless steel Grade SS304, round tube
50.8mm x 1.5mm Stainless steel tubular frame
machine bend.

FINISHING

- Hairline finish
- PVD coating

WHEELS
Imported castor 203mm foam wheels, 2 rigid & 2
swivel with thick bumpers all round.

CARPET COLOURS
Dark Grey / Maroon



BIRDCAGE TROLLEY

KENFOT-02
L1168 x D710 x H1854mm

FRAME
Stainless steel Grade SS304, round tube
50.8mm x 1.5mm Stainless steel tubular frame
machine bend.

FINISHING

- Hairline finish
- PVD coating

WHEELS
Imported castor 203mm foam wheels, 2 rigid & 2
swivel with thick bumpers all round.

CARPET COLOURS
Dark Grey / Maroon



BIRDCAGE TROLLEY

KENFOT-03
L1168 x D710 x H1854mm

FRAME
Stainless steel Grade SS304, round tube 50.8mm
x 1.5mm Stainless steel tubular frame machine
bend.

FINISHING

- Hairline finish
- PVD coating

WHEELS
Imported castor 203mm foam wheels, 2 rigid & 2
swivel with thick bumpers all round.

CARPET COLOURS
Dark Grey / Maroon



LUGGAGE CART

KENFOT-04
L1168 x D686 x H1778mm

FRAME
Stainless steel Grade SS304, round tube
50.8mm x 1.5mm Stainless steel tubular frame
machine bend.

WHEELS
Imported castor 203mm foam wheels, 2 rigid & 2
swivel with thick bumpers all round.

CARPET COLOURS
Dark Grey / Maroon



LUGGAGE CART

KENFOT-05
L1168 x D686 x H1778mm

FRAME
Stainless steel Grade SS304, round tube
50.8mm x 1.5mm Stainless steel tubular frame
machine bend.

WHEELS
Imported castor 203mm foam wheels, 2 rigid & 2
swivel with thick bumpers all round.

CARPET COLOURS
Dark Grey / Maroon



PLATFORM TROLLEY

KENFOT-06
L1168 x D686 x H1120mm

MATERIAL
Stainless steel mirror polished tubing carpeted
deck and all round bumper.

FRAME
Stainless steel Grade SS304, round tube
50.8mm x 1.5mm Stainless steel tubular frame
machine bend.

WHEELS
Imported castor 203mm foam wheels, 2 rigid & 2
swivel with thick bumpers all round.

CARPET COLOURS
Dark Grey / Maroon



HOUSE KEEPING

Keep your rooms clean and tidy with our fast and handy House Keeping Trolleys. From complex to simple and easy models, we have a wide variety to choose from to suit the occasion. Our trolleys are compartmentalised to store fresh linens and a multitude of cleaning tools, allowing your housekeepers to work efficiently and with ease.



HOUSEKEEPING
TROLLEY

KENHKT-101
W1410x D547 x H1258mm

FEATURES

- Top organizer box
- Heavy-duty one short bag & one long bag provided
- Heavy-duty 203mm diameter castors and full wrap around bumpers

FRAME

Powder coated colour
Beige 15200 / Copper hammertone / Sparking Iron Effect

CHOICE OF COLOR

Blue / Brown / Black

BAG SIZE:

Long bag size: W460 x D270 x H825
Short bag size: W460 x D270 x H573

HOUSEKEEPING
TROLLEY

KENHKT-104
W1520 x D575 x H1530mm

FEATURES

- Top organizer provided with three shelves and two end platforms
- Heavy-duty one short bag & one long bag provided
- Heavy-duty 8" castors and full wrap around bumpers
- Comes with corner guard 4 sided

HOUSEKEEPING
TROLLEY

KENHKT-102
W1490x D575 x H1235mm

FEATURES

- Top organizer with open lid provided with three shelves and two end platforms
- Heavy-duty one short bag & one long bag provided
- Heavy-duty 8" castors and full wrap around bumpers
- Comes with corner guard 4 sided

BAG SIZE:

Long bag size: W460 x D270 x H825
Short bag size: W460 x D270 x H573

HOUSEKEEPING
TROLLEY

KENHKT-105
W1410 x D547 x H1258mm

FEATURES

- Top organizer provided with three shelves and two end platforms
- Heavy-duty one short bag & one long bag provided
- Heavy-duty 8" castors and full wrap around bumpers
- Comes with corner guard 4 sided

BAG SIZE:

Long bag size: W460 x D270 x H825
Short bag size: W460 x D270 x H573

HOUSEKEEPING
TROLLEY

KENHKT-103
W1410 x D547 x H1258mm

FEATURES

- Top organizer provided with three shelves and two end platforms
- Heavy-duty one short bag & one long bag provided
- Heavy-duty 8" castors and full wrap around bumpers
- Comes with corner guard 4 sided

BAG SIZE:

Long bag size: W460 x D270 x H825
Short bag size: W460 x D270 x H573

THREE-BAGS
SORTING
TROLLEY

KENHKT-106
3 CANVAS BAGS
W1194x D559 x H915mm

FRAME

Mild steel in powder coated with all round PU bumper

WHEELS

155mm diameter heavy-duty wheels

COLOUR

Blue / Brown / Black



VALET
TROLLEY

KENHKT-108
W1155 x D555 x H1715mm

FEATURES

- Stainless steel hanger frame
- Mild steel shelving with powder coated finish

WHEELS

155mm diameter heavy-duty wheels

X-FRAME
TROLLEY

KENHKT-111
W685 x D559 x H902mm

FRAME

Mild steel powder coated frame with
1" diameter x 1.2mm thickness

WHEELS

4 nos 100mm diameter heavy-duty wheels

FEATURES

- Heavy-duty canvas bag.

CHOICE OF COLOR

Blue / Brown / Black

FIBREGLASS
TROLLEY

KENHKT-109
W966 x D686 x H925mm

MATERIAL

Fiber Glass

WHEELS

4 nos 155mm diameter heavy-duty wheels

FEATURES

- All round PU bumper

HOUSEKEEPING
TROLLEY

KENHKT-112
W1135 x D575 x H1445mm

WHEELS

Heavy-duty 155mm diameter wheels

FEATURES

- Mild steel powder coated frame
- Comes with two doors and two laminated panel shelveings

SOILED LINEN
TROLLEY

KENHKT-110
W1016 x D711x H915mm

WHEELS

155mm diameter heavy-duty wheels

FEATURES

- Mild steel powder coated finish
- Heavy-duty canvas bag
- All round PVC bumper

CHOICE OF COLOR

Blue / Brown / Black

LINEN CAGE
TROLLEY

KENHKT-113
W1135 x D575 x H1445mm

WHEELS

Heavy-duty 155mm diameter wheels

FEATURES

- Mild steel powder coated frame
- Comes with one door and two laminated removable shelveings
- All round PU bumper



PLATFORM TROLLEY

KENHKT-114
W1160 x D750 x H1070mm

MATERIAL
Stainless steel in SS304 grade finish
c/w 204mm diameter rubber wheels

KENHKT-115
W1190 x D750 x H1120mm

Material
Mild steel powder coated finish c/w chequer plate
top with 204mm diameter rubber wheels



SOLID LINEN TROLLEY

KENHKT-116
W1016 x D700 x H915mm

FRAME
Mild steel in powder coated finish with centre
divider, all round PU bumper

WHEELS
Heavy-duty 155mm diameter wheels



SOLID LINEN TROLLEY

KENHKT-117
W1016 x D700 x H915mm

FRAME
Mild steel in powder coated finish with all round
PU bumper

WHEELS
Heavy-duty 155mm diameter wheels



COAT HANGER

KENHKT-118
Ø330 x H1855mm

MATERIAL

- Stainless steel grade SS 304
- Round tube 38mm x 1.2mm thickness



SKIRTING TROLLEY

KENHKT-119
W1753 x D482 x H1892mm

MATERIAL
Stainless steel grade SS 304 in brushed hairline
finish with 25mm round tube x1.2mm thickness

WHEELS
4 nos heavy-duty 100mm swivel expansion wheels



DOUBLE RAIL GARMENT TROLLEY

KENHKT-120
W1524 x D711 x H1830mm

MATERIAL
Stainless steel Grade SS 304, round tube 32mm
x 1.2mm thickness stainless steel tubular frame
machine bend

WHEELS
4 nos of heavy-duty wheels



GARMENT TROLLEY

KENHKT-121
W1753 x D482 x H1892mm

MATERIAL

Stainless steel grade SS 304 in brushed hairline finish with 25mm round tube x1.2mm thickness

WHEELS

4 nos heavy-duty 100mm swivel expansion wheels



LUGGAGE RACK

KENHKT-124
W610 x D508 x H762mm

MATERIAL

- Mild steel Round Tube
- Bumpered back bar
- Unique screw-through-clip replaceable heavy-duty nylon straps

COLOUR

Powder coated finish. Chrome option available



LUGGAGE RACK

KENHKT-125
W610 x D508 x H610mm

MATERIAL

- Mild steel Round Tube
- Bumpered back bar
- Unique screw-through-clip replaceable heavy-duty nylon straps

COLOUR

Powder coated finish. Chrome option available



WOODEN LUGGAGE RACK

KENHKT-129
W762 x D432 x H635mm

MATERIAL

Nyatoh wood without backrest and comes with heavy-duty nylon straps.

** Nylon Strap Colour Brown / Black



DUMMY WAITER

KENHKT-122
W508 x D533 x H813mm

MATERIAL

Mild steel Round Tube

FEATURES

- Comes with heavy-duty nylon straps with lightweight and durable for effective and quick service

COLOUR

Powder coated finish. Chrome option available



WOODEN FOLDABLE TRAY STAND

KENHKT-123
W585 x D400 x H900mm

FEATURES

- Wood in mahogany colour and comes with heavy-duty nylon strap



TWO-TIER FOLDABLE TRAY STAND

KENHKT-127
W580 x D400 x H900mm

FEATURES

- Nyatoh wood finish in mahogany colour
- Easy storage



ROOM SERVICE TROLLEY



ROOM SERVICE TROLLEY

**ROUND TRIFOLD SERVICE
TROLLEY KENRST-401**
Ø915mm x H787mm

**OVAL TRIFOLD SERVICE
TROLLEY KENRST-402**
W1067 x D915 x H787mm

**SQUARE TRIFOLD ROOM
SERVICE TROLLEY KENRST-403**
W915 x D915 x H787mm



FEATURES

- Tabletop in laminated 18mm plywood with heavy duty T-Mould PVC edging for easy maintenance and durability
- 5" heavy-duty polyurethane non marking wheels are used for smooth and silent movement during usage
- Mainframe is made from 25mm x 50mm x 1.6mm mild steel tube in powder coated finish
- Additional bars and tubes are added for extra strength and durability
- All joints are fully welded
- Nylon bolts and nuts are used in areas where there is movement



Handle for easy handling



Folding mechanism

SQUARE ROOM SERVICE TROLLEY

OVAL FIVE-FOLD ROOM SERVICE TROLLEY KENRST-404

W1062 x D915 x H770mm

Tabletop

Tabletop in laminated 18mm plywood with heavy duty T-Mould PVC edging for easy maintenance and durability.

Frame

- 5" heavy-duty polyurethane non marking wheels are used for smooth and silent movement during usage
- Stainless steel mainframe
- Nylon bolts and nuts are used in areas where there is movement
- Space saving
- Easy lock mechanism



ELECTRIC FOOD WARMER

KENRST-501

Stainless steel frame.

KENRST-502

Stainless steel frame with Black powder coated finish
W410 x D370 x H490(mm)

FEATURES

- Double-wall frame construction prevents the exterior of the box from getting hot and at the same time keeps the heat insulated in the box
- Customised door-lock keeps door tight during usage and prevents heat from getting out
- Top handle and 2 side handles are fitted to make it easy to carry warmers during operations
- Single long stainless steel hinge is fixed for extra strength
- Each unit is 240 volts and comes with a conventional 3-prong plug
- Each unit has 3 removable aluminium shelves



Exterior of the unit is made from stainless steel to enable easy maintenance and durability. Interior is fitted with aluminium. Both materials are rust-free making it hygienic.

FOOD WARMER CADDY

KENRST-405

W1067 x D508 x H1675mm

FEATURES

- Material is made of mild steel frame with 25mm x 50mm x 1.6mm mainframe which is welded together for extra strength
- Standard colour is matt black texture powder coated finish
- 5" heavy-duty non marking polyurethane castors fitted for easy movement
- 2 nos with top brake to prevent movement when stationary
- Capacity 6 nos per rack (warmers)



CLEAR TEMPERED GLASS
with revolving aluminium ring

KENBQT-30
Ø760mm (30")

THICKNESS
10mm

KENBQT-36
Ø915mm (36")

Revolving aluminum ring with ball bearing size: 16/18/24" diameter following the increase in glass size

KENBQT-40
Ø1015mm (40")

KENBQT-48
Ø1220mm (48")



LAZY SUSAN TROLLEY

KENBQT-301
W1067 x D635 x H1448mm

FEATURES

- Custom-built capacity 20 nos.
- Stores multiple glass sizes from 42" diameter to 24" diameter with top ring tray
- Comes with dome ensured base with both safety bars on each end



RETRACTABLE QUEUING STANCHION STAND

KENBQT-801
Ø331 x H915mm

MATERIAL
Stainless Steel in round tube

BELT LENGTH
6ft

BELT COLOUR
Red / Black / Blue



RETRACTABLE QUEUING STANCHION STAND

KENBQT-802
Ø331 x H915mm

MATERIAL
Stainless steel in round tube black powder coated

BELT LENGTH
6ft

BELT COLOUR
Red / Black / Blue



RETRACTABLE QUEUING STANCHION STAND

KENBQT-803
Ø331 x H915mm (stand only)

MATERIAL
Stainless steel in round tube

BELT LENGTH
6ft with A4 signboard

BELT COLOUR
Red / Black / Blue



HEAVY-DUTY QUEUING STANCHION POST

KENBQT-804
Ø330 x H1016mm

MATERIAL

- Stainless steel grade SS 304
- Brass finish option available



HEAVY-DUTY QUEUING ROPE

KENBQT-805

MATERIAL
Solid Rope with Velvet
Stainless steel hook at both ends

BELT LENGTH
5ft

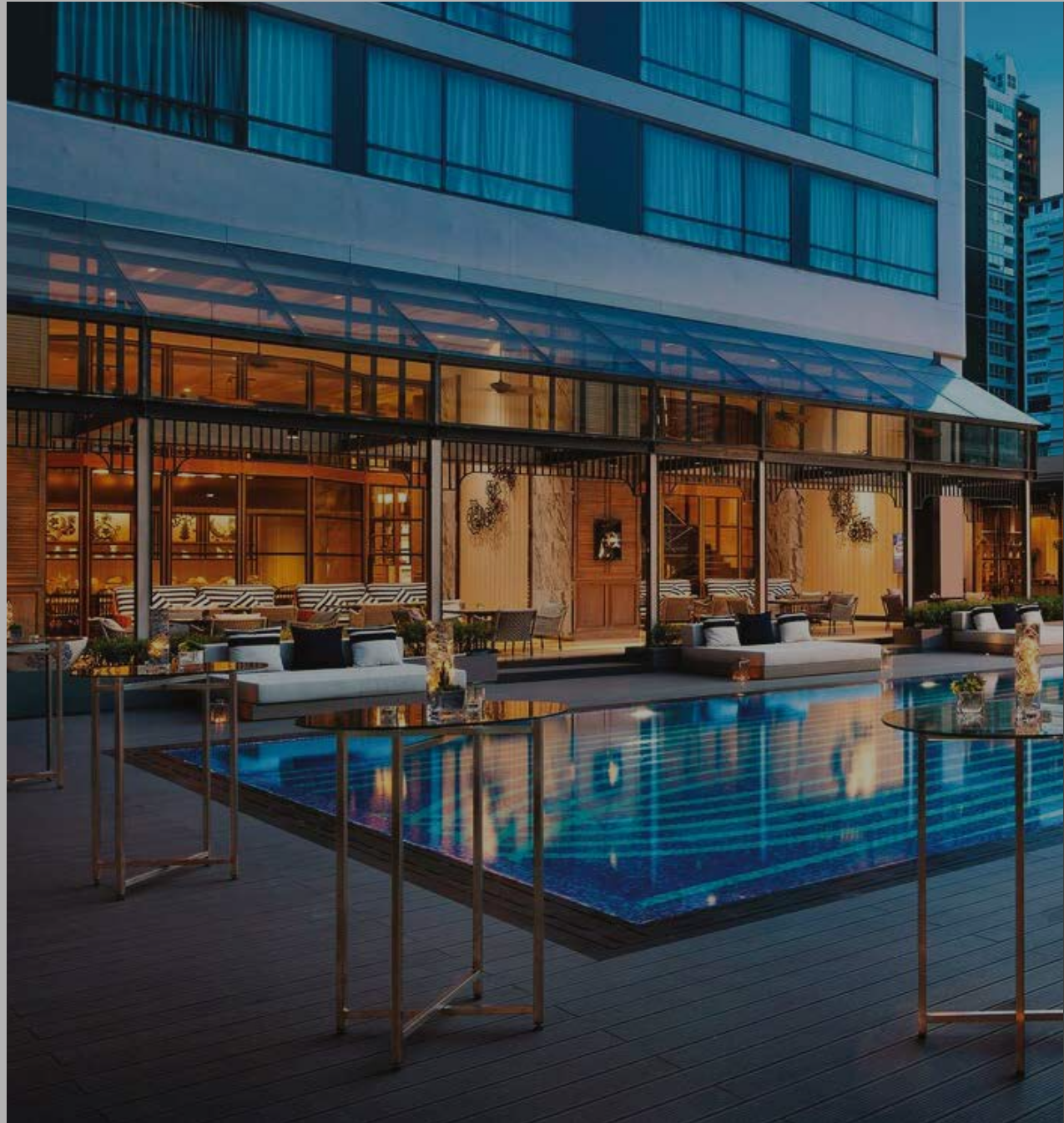

TABLE NUMBERING STAND

KENBQT-806
Ø115 x H445mm

MATERIAL
Mild Steel chrome finished with double sided numbering acrylic plate





MATERIALS & SWATCHES

Galaxy II Fabric

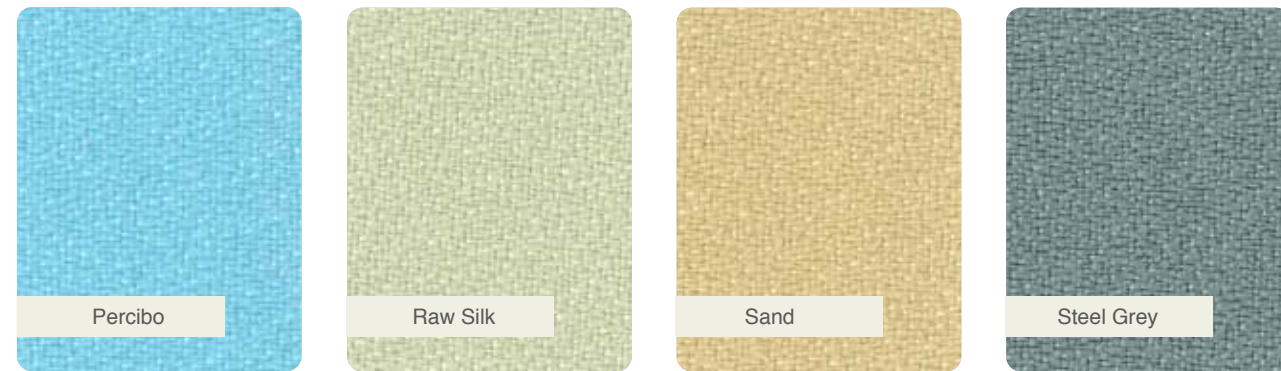
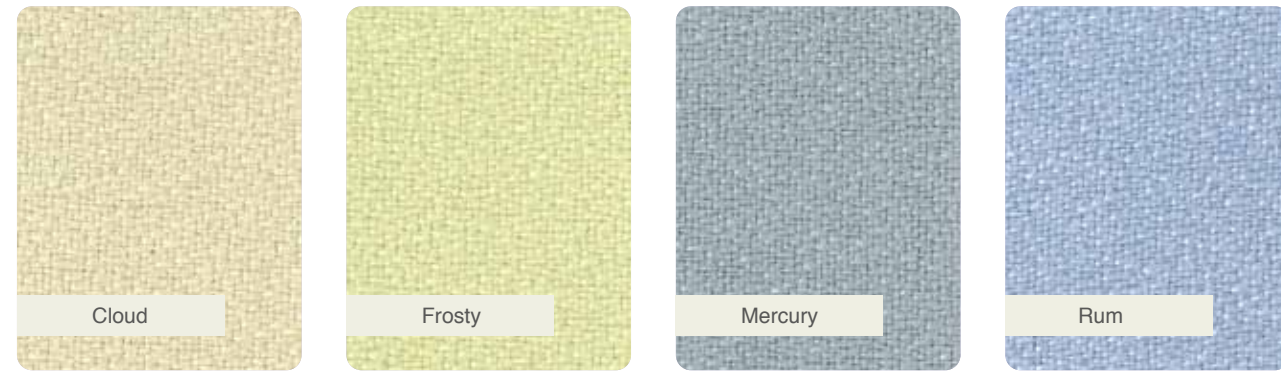

Content:	100% Polyester
Width:	165cm
Abrasion Resistance BS5690:1991 Option 1 Martindale tester:	100,000 rubs
Pilling Resistance ASTM - D3512-10	Grade 4-5
Colorfastness To Crocking AATCC 8-2003 Dry Class / Wet Class	4-5

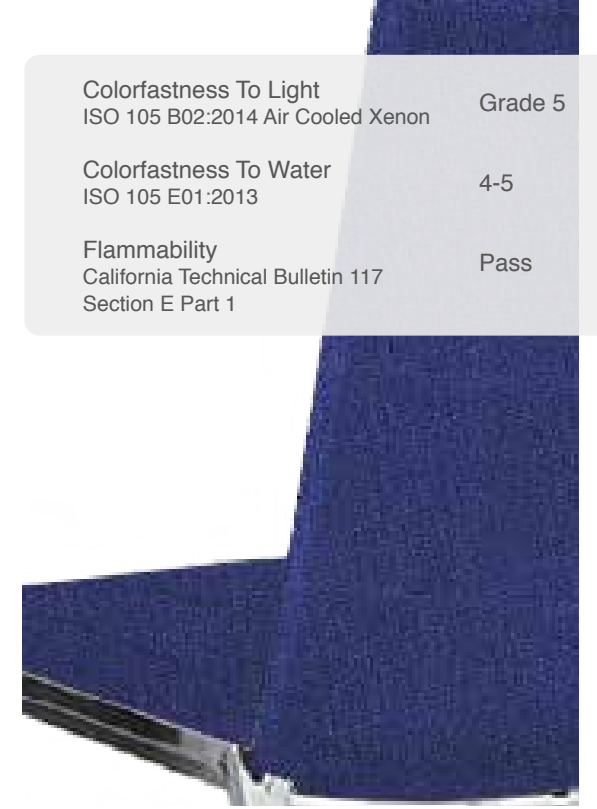

Galaxy II Fabric



Oxidize

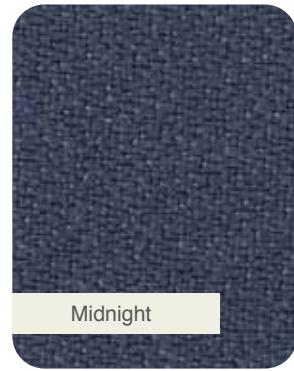

Midnight



Indigo

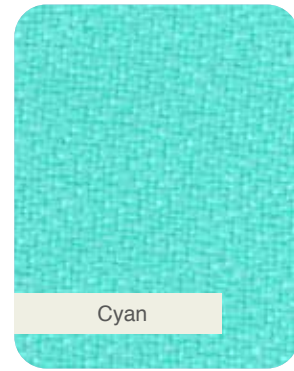

Cyan

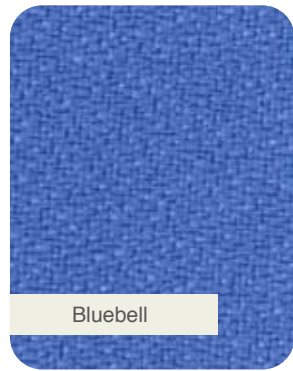

Bluebell



Violet Storm

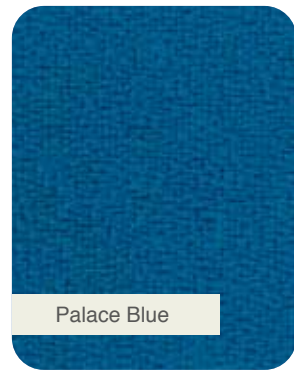

Palace Blue

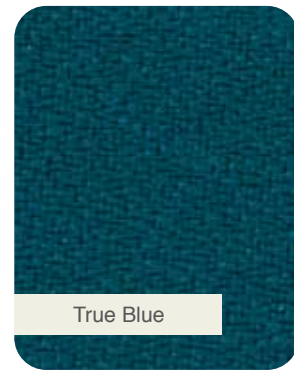

True Blue



Apple Green

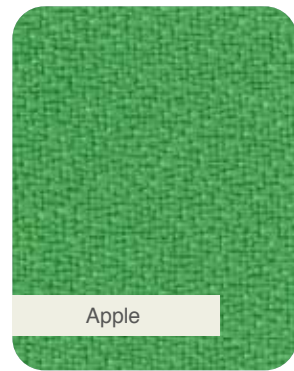

Apple

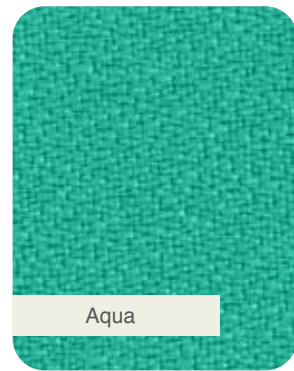

Aqua

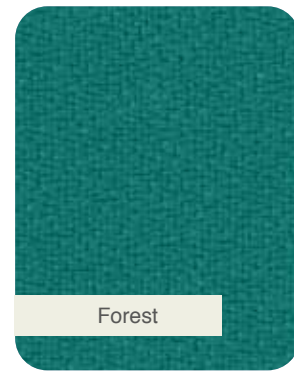

Forest

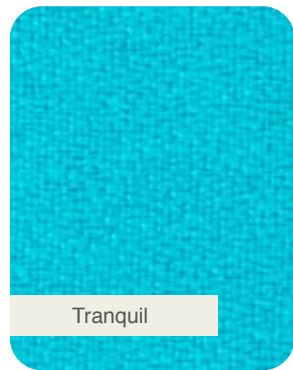

Tranquil

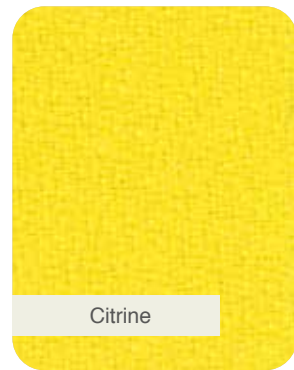

Citrine

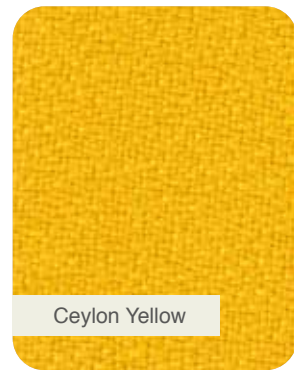

Ceylon Yellow

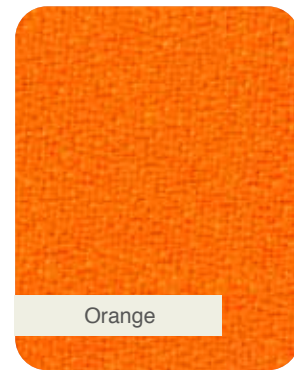

Orange

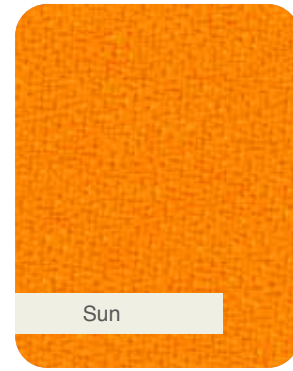

Sun

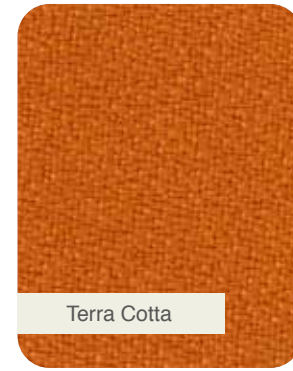

Terra Cotta

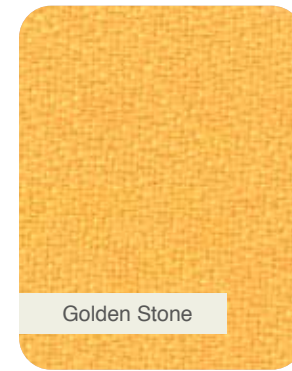

Golden Stone



Wild Red

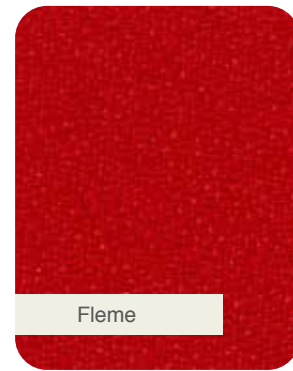

Fleme



Crimson



Ruby Wine



Turile



Cinder



Amethyst

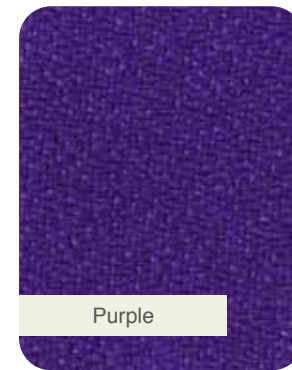

Purple

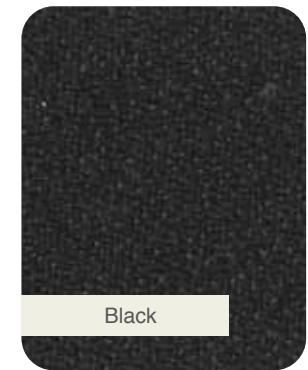

Black

Cardiff Fabric

Beat	Strobe	Vibe	Sand
Ivory	Alto	Techno	Bariton
Violet	Scene	Décor	Move
Loud			

Content: 100% Polyester
 Width: 150cm
 Abrasion Resistance: 175,000 Cycles
 Test Methods: ASTM D4157-2007
 Tensions / Compression Force: 4 LB / 3LB
 Flammability: BS EN 1021 - 1: 2006 (Cigarette)

Carpet

Green	Black	Maroon	Brown
Cotton Blue	Blue		

Fibre: STRUDON Polypropylene BCF
 Construction: Level Loop
 Dye method: Solution Dyed
 Pile Height: 5,5mm
 Pile Weight: 700G Gr / M²
 Primary Backing: Woven Polypropylene
 Secondary Backing: Action Back
 Standard Roll Length: 35 meter
 Standard Roll Weight: 300 KG

High Pressure Laminates

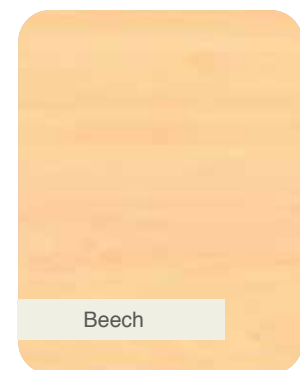
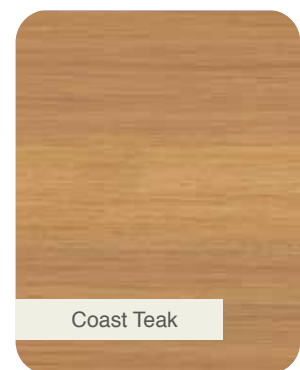
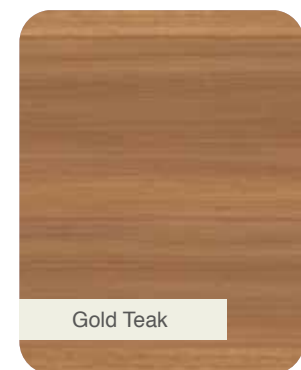
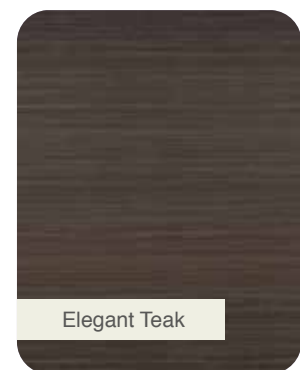
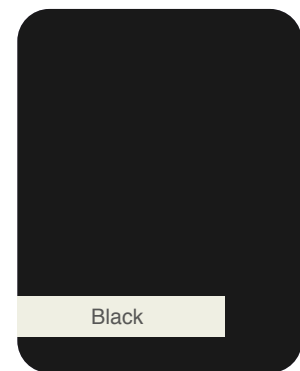
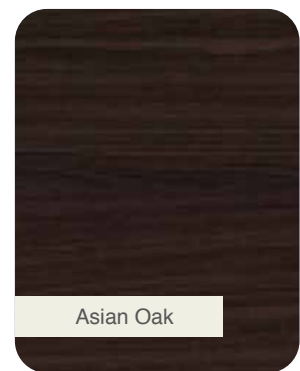
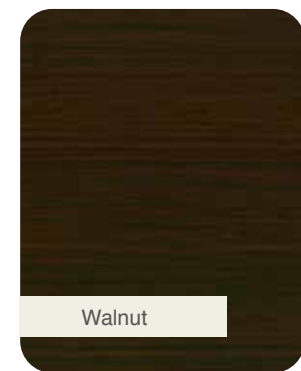
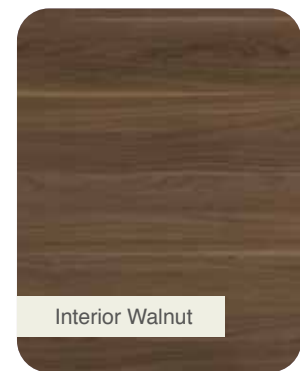
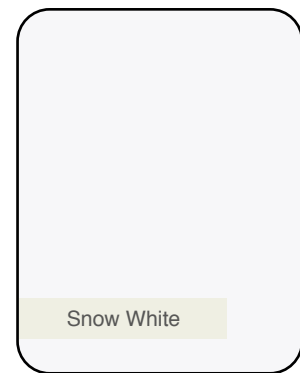

Powdercoating Colours

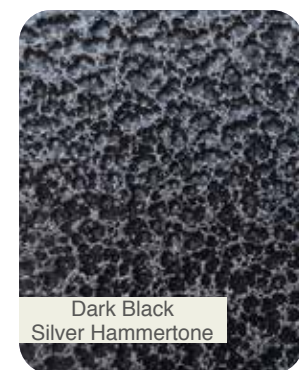
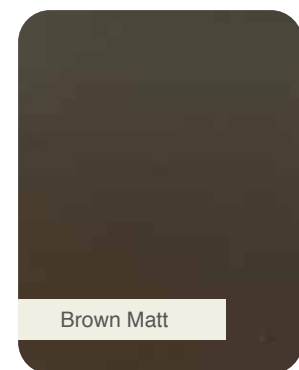
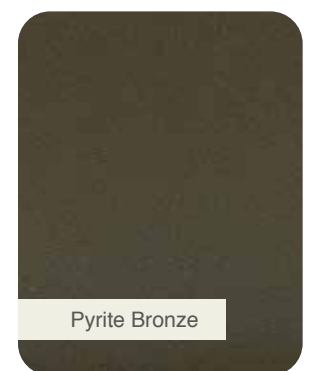
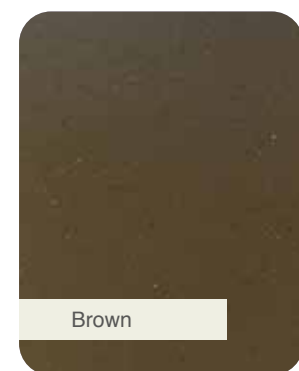
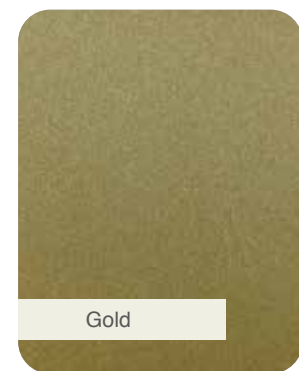
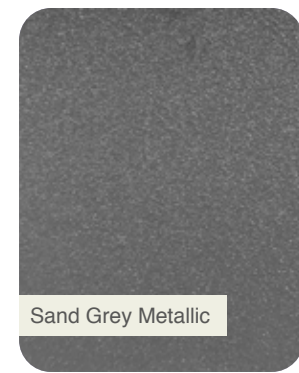
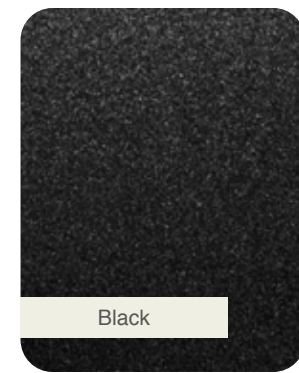
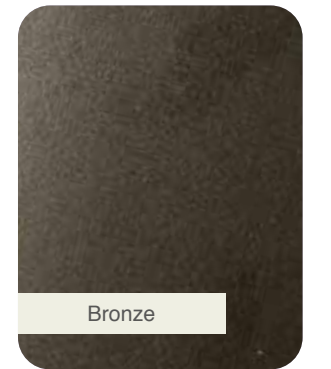
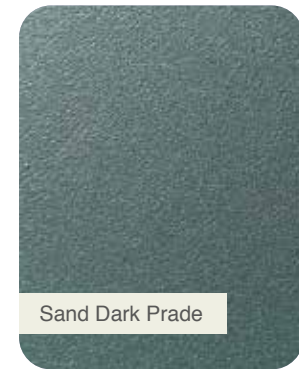
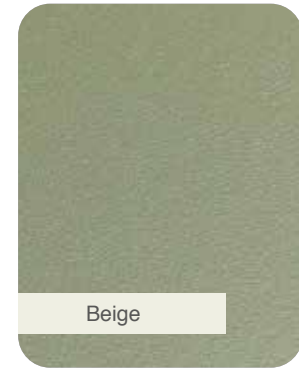









All photographs, artist's impressions, plans, measurements and colour representations are intended for illustrative and informative purposes only. They cannot be regarded as representations of fact and are subject to change at any time. Actual finishes and details may vary. No reproduction or republication of this copyrighted catalogue and/or its concept is permitted, whether in whole or in part.



Kian®

Better Design, Better Value, Better World

-  www.kian.com
-  hello@kian.com
-  Kian Group of Companies
-  [kianfurniture](#)
-  [kianmarketing](#)
-  [kianfurniture.official](#)